

Data sheet

OpDAT Wall-mounted distributor S 6xSC-D OM5 splice

Page 1/5

P/N

150328BM06-E

EAN 4251394666556

2023/04/26

Version: A

Illustrations



Dimensional drawing

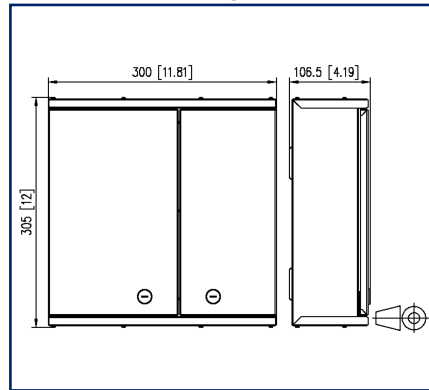

Drill pattern

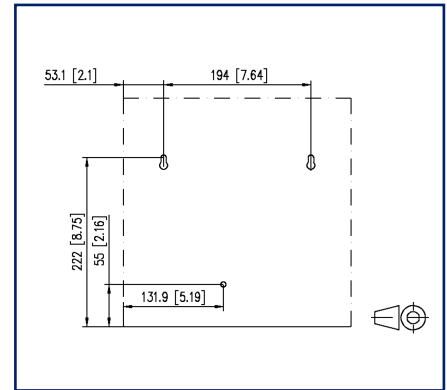

See enlarged drawings at the end of document

Product specification

- distributor for universal use in floor cabling or as a building distribution point in the equipment room
- equipped with SC-D-adapters and pigtails
- pigtails inserted and stripped in standard splice tray with crimp splice holders
- unused openings are closed by blind plugs
- wall-mount housing with two lockable swing doors, two different locks to separate network and building cabling
- easy, space saving wall mounting
- easy access possibilities and a secure routing of the pigtails
- four cable infeeds (scope of supply): 2x for M20/PG16, 2x for patch cords
- variants: size S: 305x300x107 mm or size M: 405x400x107 mm

P | Cabling

Data sheet

Page 2/5

OpDAT Wall-mounted distributor S 6xSC-D OM5 splice

P/N

150328BM06-E

EAN 4251394666556

2023/04/26

Version: A

Technical Data

General Data

Fields of application	structured building cabling office areas data center
Mechanical measurement according to MICE	M1
Ingress measurement according to MICE	I1
Climatic measurement according to MICE	C1
Electromagnetic measurement according to MICE	E3
Design	Wall-mounted distributor
Mounting style	AP
Transmission technology	Fiber optic
Port numbering	yes
Color	lime green
Dimensions	
Dimension (L x W x H)	106.5 mm x 300 mm x 305 mm
Dimension (L x W x H)	4.193 in. x 11.811 in. x 12.008 in.
Cable Type	pigtail(s)
Fiber class	OM5
Mode type of the fiber	Multimode
Shape	PC (Physical Contact)
Fiber construction	50/125 µm
Labeling option	printed numbers

Connections/interfaces

Connector technology interface 1	SC-D Couplers
Connector technology interface 2	SC-D Couplers
Number of ports interface 1	12
Number of ports interface 2	12
Number of equipped ports interface 1	6
Number of ports interface 2 equipped	6
Cable access/outlet	from top or bottom

OpDAT Wall-mounted distributor S 6xSC-D OM5 splice

P/N

150328BM06-E

EAN 4251394666556

2023/04/26

Version: A

Technical Data

Mechanical data

Cut-out	SC-D, LC-Q, ST-D
Connector type	duplex

Materials and material properties

Material - Housing	sheet steel
Material - Housing finish	powder-coated
Material - Front cover	sheet steel
Material - Front cover finish	powder-coated
Material - Sleeve	ceramic, slotted
Material - Coupler housing	Plastics
Halogen free	yes
RoHS	compliant

Standards/Regulations

Fibre optic connector interfaces	IEC 61754-4
Optical fibers - Interconnecting devices and passive components - basic test and measuring methods	
Fibre optic interconnecting devices and passive components	IEC 61300-3-4
Fibre optic interconnecting devices and passive components	IEC 61300-3-6
Fibre optic interconnecting devices and passive components	IEC 61300-3-35
Standard colours for insulation for low-frequency cables & wires	IEC 60304

Classifications

ETIM 7.0	EC001130
ETIM 8.0	EC001130
ETIM 9.0	EC001130

Packing details

Type of packaging	1 pc(s) / box
-------------------	---------------

P | Cabling

Data sheet

Page 4/5

OpDAT Wall-mounted distributor S 6xSC-D OM5 splice

P/N

150328BM06-E

EAN 4251394666556

2023/04/26

Version: A

Accessories

P/N	Designation
15032Z001-E	Cable infeed for 2xM20 for OpDAT Wall-mounted distributor S
15032Z003-E	Cable infeed for 1xM25 for OpDAT Wall-mounted distributor S
15032Z004-E	Cable infeed for two mounting plates VIK for OpDAT Wall-mounted distributor
15032Z005-E	Cable infeed for patch cords for OpDAT Wall-mounted distributor S
15032Z006-E	Cable infeed for single cable for OpDAT Wall-mounted distributor S
15032Z089-E	OpDAT WV rotary bolt
15090200-E	OpDAT cover for splice tray

P | Cabling

Data sheet

Page 5/5

OpDAT Wall-mounted distributor S 6xSC-D OM5 splice

P/N

150328BM06-E

EAN 4251394666556

2023/04/26

Version: A

Illustrations

Dimensional drawing

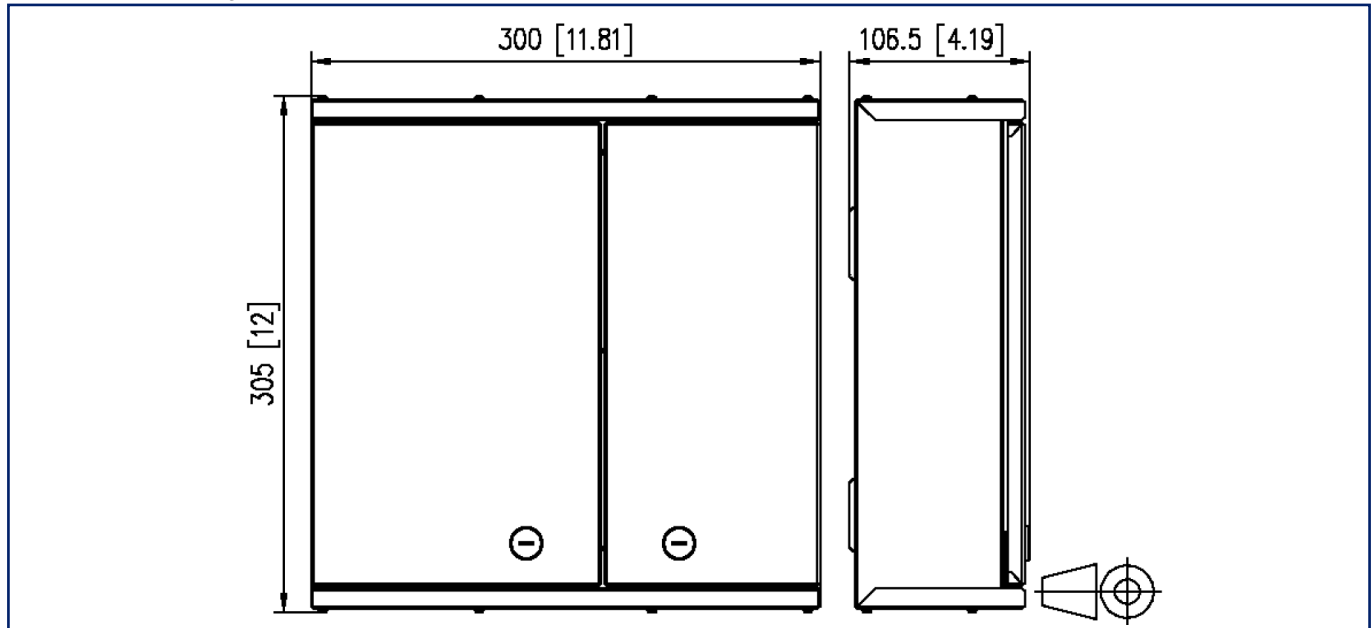

Drill pattern

