

Data sheet

OpDAT pigtail ST-UPC, OS2, 6 color

Illustrations

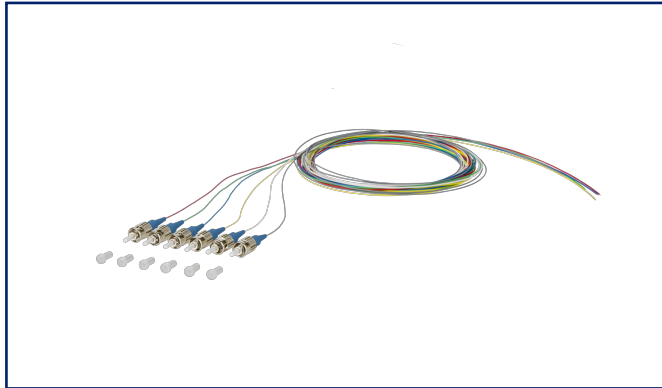

Dimensional drawing

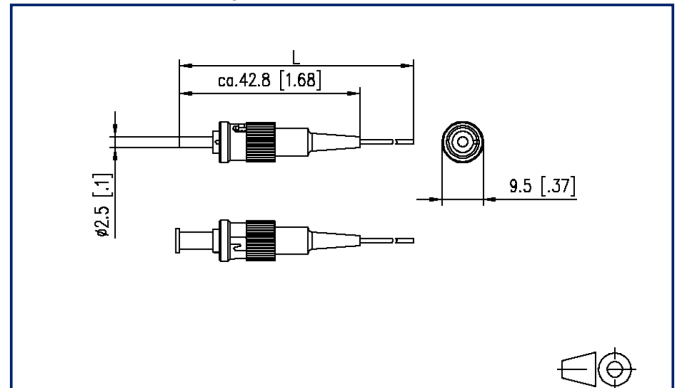

See enlarged drawings at the end of document

Product specification

- ST plug according to IEC 61754-2
- Single mode fiber OS2, E9/125 μm , bend insensitive according to IEC 60793-2-50 type B6_a and G.657.A1 compatible to G.652.D
- Compact loose tube fiber with dia. 0.9 mm, length 2.0 m
- Color sequence in sets according to IEC 60304: red, green, blue, yellow, white, gray, brown, violet, turquoise, black, orange, pink. Secondary and primary coating same color
- Plug connector mounted on one side
- With test report, insertion loss and return loss tested at 100 %
- all available variants can be created with the cable configurator

P | Cabling

Data sheet

Page 2/6

OpDAT pigtail ST-UPC, OS2, 6 color

P/N

150Q1AO0020E6

EAN 4251122189906

2023/06/02

Version: M

Technical Data

General Data

Fields of application	office areas data center
Mechanical measurement according to MICE	M1
Ingress measurement according to MICE	I1
Climatic measurement according to MICE	C1
Electromagnetic measurement according to MICE	E3
Design	pigtail
Transmission technology	Fiber optic
Color	metallike
Dimensions	
Dimension (L x W x H)	42.8 mm x 9.5 mm x 9.5 mm
Dimension (L x W x H)	1.685 in. x 0.374 in. x 0.374 in.
Mode type of the fiber	Singlemode
Fiber class	OS2
Fiber standard	ITU-T G.657.A1, IEC 60793-2-50 B1.3 B6_a
Cable Type	pigtail(s)
Number of cables/ buffered fibers	6
Number of fibres each cable/ wire	1
Shape	UPC (Ultra Physical Contact)
Fiber construction	9/125 µm
Cable length (m)	2 m
Cable length (ft)	6.56 ft

Connections/interfaces

Connector technology interface 1	ST UPC
Connector technology interface 2	free line end
Primary coating diameter	0.25 mm
Primary coating diameter	0.01 in.
Secondary coating diameter	0.9 mm
Secondary coating diameter	0.035 in.
Ferrule diameter	1.25 mm
Ferrule diameter	0.049 in.

P | Cabling

Data sheet

Page 3/6

OpDAT pigtail ST-UPC, OS2, 6 color

P/N

150Q1AO0020E6

EAN 4251122189906

2023/06/02

Version: M

Technical Data

Optical characteristics

Insertion loss	max. 0,4 dB
Return loss	min. 50 dB

Mechanical data

Insertion and withdrawal force	min. 5 N
Minimum bending radius	15 mm
Minimum bending radius	0.59 in.

Materials and material properties

Material - Housing	metal
Bend insensitivity	yes
Halogen free	yes
RoHS	compliant

Environmental conditions

Temperature (min. - max.)	
Temperature - Storage °C	-20 °C - 60 °C
Temperature - Storage °F	-4 °F - 140 °F
Temperature - Operating °C	-20 °C - 60 °C
Temperature - Operating °F	-4 °F - 140 °F

Standards/Regulations

Generic cabling systems	
General requirements	ISO/IEC 11801
Fibre optic connector interfaces	IEC 61754-2
Optical fibers: Indoor optical cables	
Sectional specification for classÂ B single-mode fibres	ISO/IEC 60793-2-50 type B.1.3 & B6_a
Optical fibers - Interconnecting devices and passive components - basic test and measuring methods	
Fibre optic interconnecting devices and passive components	IEC 61300-3-4 IEC 61300-3-6
ITU-T standard	G.657.A

P | Cabling

Data sheet

Page 4/6

OpDAT pigtail ST-UPC, OS2, 6 color

P/N

150Q1AO0020E6

EAN 4251122189906

2023/06/02

Version: M

Technical Data

Classifications

ETIM 5.0	EC000748
ETIM 6.0	EC000748
ETIM 7.0	EC000748
ETIM 8.0	EC000748
ETIM 9.0	EC000748

Packing details

Type of packaging	6 pc(s) / blister packaging
Packaging dimension	300 mm x 200 mm x 20 mm
Packaging dimension	11.811 in. x 7.874 in. x 0.787 in.



P | Cabling

Data sheet

Page 5/6

OpDAT pigtail ST-UPC, OS2, 6 color

P/N

150Q1AO0020E6

EAN 4251122189906

2023/06/02

Version: M

Accessories

P/N	Designation
15090401-E	OpDAT crimp splice protection (12 pieces)
15090401-I	OpDAT crimp splice protection (150 pieces)
15090402-I	OpDAT shrink splice protection

© 2023 METZ CONNECT - Technische Änderungen vorbehalten! Subject to modifications! Sous réserve de modifications techniques!



P | Cabling

Data sheet

OpDAT pigtail ST-UPC, OS2, 6 color

Page 6/6

P/N

150Q1AO0020E6

EAN 4251122189906

2023/06/02

Version: M

Illustrations

Dimensional drawing

