

Illustrations

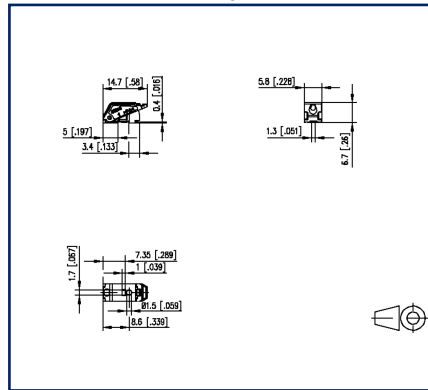

Dimensional drawing



PCB-Layout

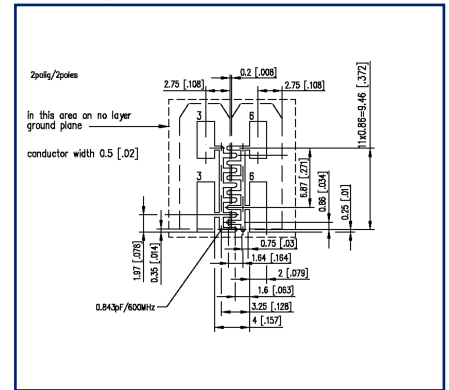



See enlarged drawings at the end of document

Product specification

- ethernet-capable spring clamp terminal block, SMT solderable
- direction of connection 90°
- fittable without loss of poles
- color brown
- Tape & Reel packaging
- finger push-button
- test point and wire connection indicator
- Variants: black, creme white, yellow, green, red, blue, orange, gray, brown, white

Technical Data

General Data	
pole size	1
Insulating material class	CTI 600
Protection category	IP20
Min. insul. strip length	7 mm
Rated current	9 A
Terminal data	
rat.wiring solid AWGmax	0.2 mm ² - 1.5 mm ² / AWG 24 - AWG 16
rat.wiring strand.AWGmax	0.2 mm ² - 1.5 mm ² / AWG 24 - AWG 16
Approvals	
 V / A / AWG	300 / 9 / 24 - 16
approval UL - File No.	E121004
 0.75 mm ²	9 A / T60
Transmission characteristics	
2-pole Data transmission according to IEEE 802.3cg	10 Mbit/s up to 1.000 m STP
2-pole Data transmission according to IEEE 802.3bp	1Gbit/s up to 15 m UTP 1Gbit/s up to 40 m STP
4-pole Data transmission according to IEEE 802.3i/u/y	10/100 MBit/s up to 100 m
8-pole Data transmission according to IEEE 802.3ab	1 GBit/s up to 100 m
8-pole Data transmission according to IEEE 802.3an	10 GBit/s up to 100 m
2-pole Power transmission	PoDL, IEEE 802.3bu 60 W
4-pole Power transmission	PoE, IEEE 802.3af, 15,4 W PoE+, IEEE 802.3at, 30 W
8-pole Power transmission	PoE, IEEE 802.3af, 15,4 W PoE+, IEEE 802.3at, 30 W 4PPoE, IEEE802.3bt, 90 W
Material	
insulating material	PPA
flammability class	V0
spring material	Spring steel
contact material	CuSn

Technical Data

Contact surface	Sn
Glow-Wire Flammability GWFI	850 °C acc. to IEC 60695-2-12
Glow-Wire Flammability GWIT	775 °C acc. to IEC 60695-2-13
Climatic Data	
upper limit temperature	105 °C
lower limit temperature	-40 °C
general	
Tolerance	ISO 2768 -mH
Solderability	reflowable
Note PCB compensation	The PCB compensation is necessary to achieve the specified data transmission specifications

Illustrations

Dimensional drawing

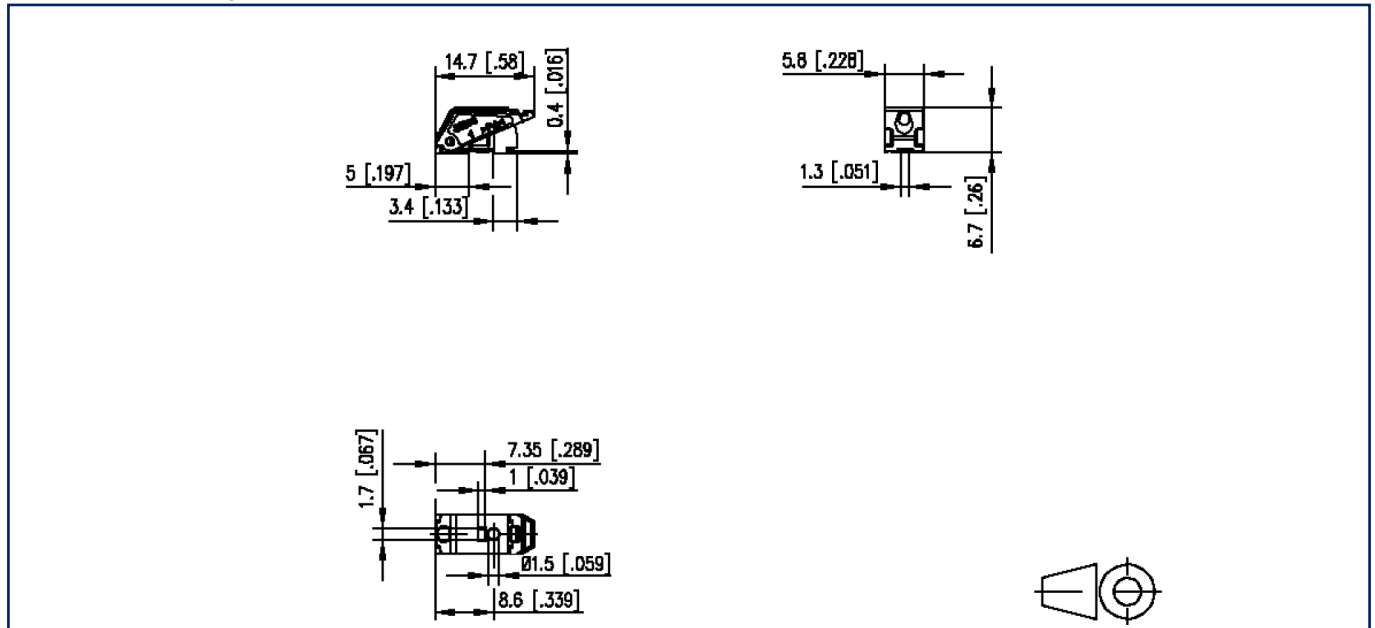

PCB-Layout

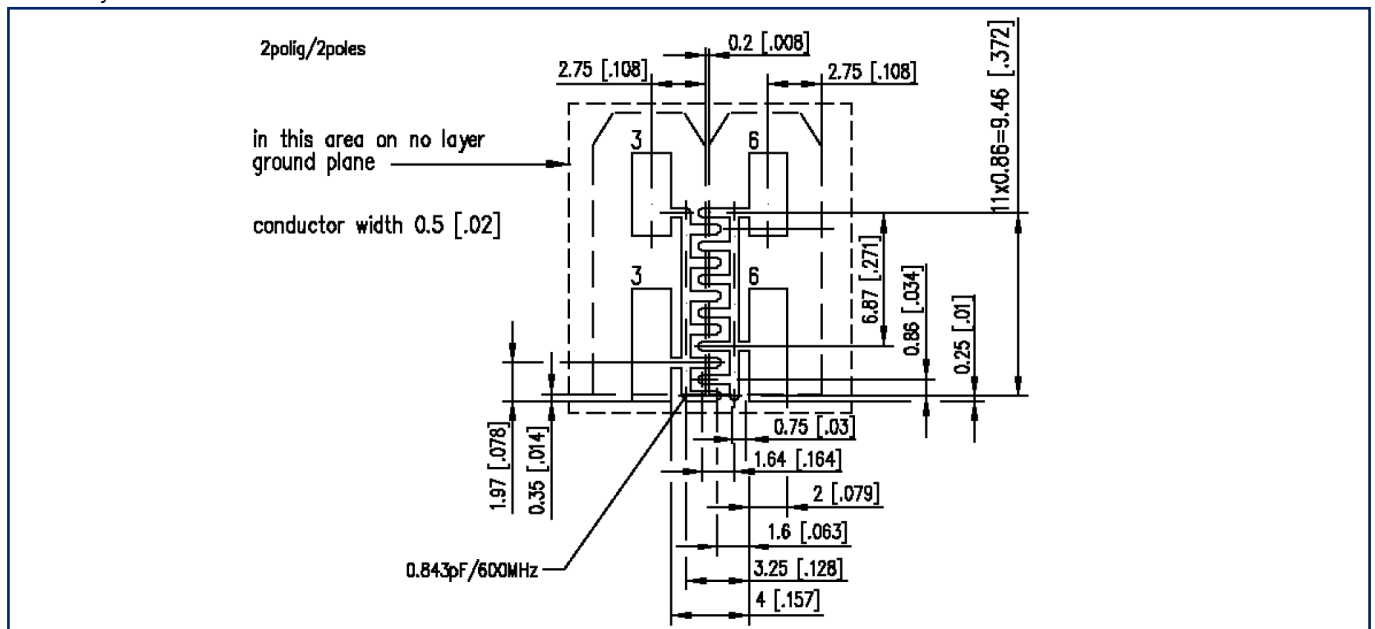

Illustrations

PCB-Layout

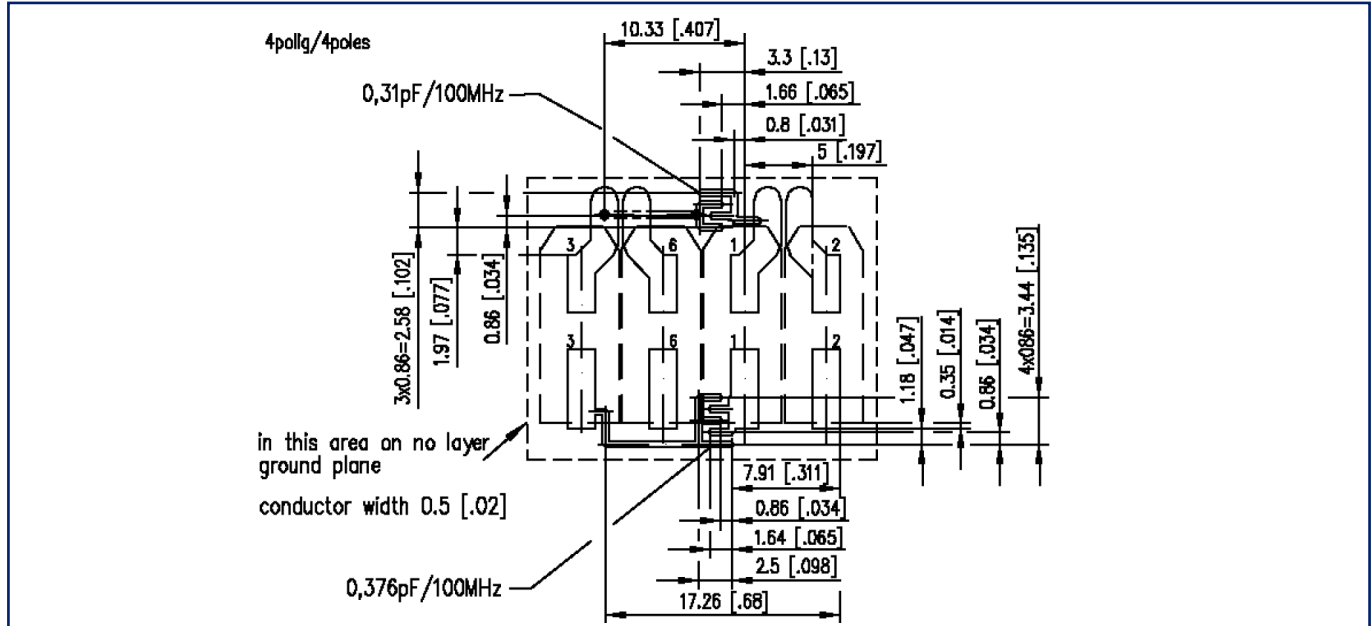

PCB-Layout

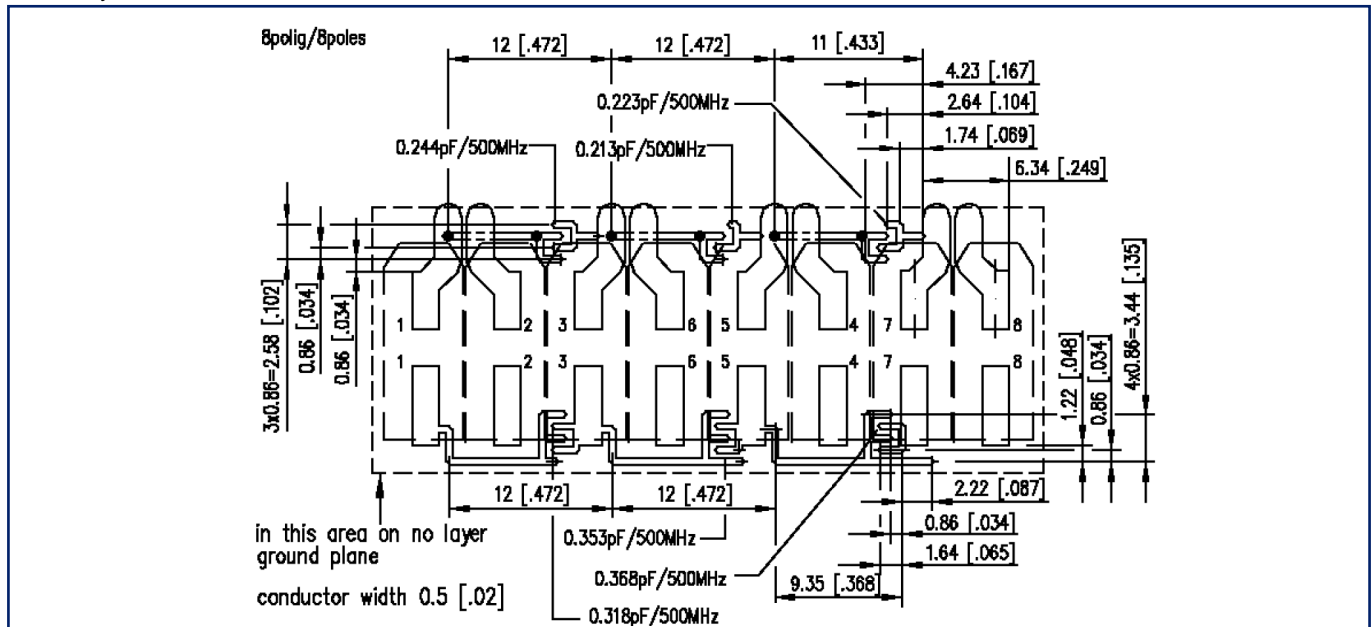

Illustrations

PCB-Layout

